

FreeSpace FS4SE

surface-mount loudspeaker

Product Overview

FreeSpace FS loudspeakers are the next step of our widely trusted line of in-ceiling and surface-mount loudspeakers, offering significant upgrades in durability, design, and ease of installation — all with remarkably consistent tonality. Engineered for high-quality performance in both background music and voice announcement applications, FS loudspeakers are ideal for almost any commercial space. The line includes five loudspeakers, two distinct levels of sound, new mounting options, and a modern aesthetic to match. For those seeking consistent, quality installed sound, FreeSpace FS loudspeakers are the perfect mix of performance and value.

The FS4SE is an in-ceiling model with a full-range 4.5-inch transducer, low frequency range down to 70 Hz, and sensitivity of 89 dB SPL / 1W @ 1m.



Key Features

- Maintain consistent tonal quality** with shared voicing across all FS models
- Hear the best of both — music and voice** — with transducers that offer clear voice reproduction and smooth response for background music
- Customize systems with confidence** using in-ceiling, surface-mount, and pendant-mount options, allowing for tailored mix-and-match installations. DesignMax subwoofers and larger models can expand your system design options even further
- Blend with more room designs** with updated enclosures — available in black and white — that pair modern aesthetics with practical features, including removable logos
- Tackle site-specific challenges** with the support of a full suite of accessories, designed to handle a wide range of applications and mounting options
- Install with ease** — all models feature Euroblock inputs and front-baffle input location on in-ceiling models
- Support public safety** — EN54-24 for Voice Alarm Systems for Fire Detection and Fire Alarm Systems for Buildings. UL 1480 UUMW listed for use in fire alarm and signaling systems in life safety applications
- Bring quality sound to more places** with the FS4SE — rated for outdoor, wet installations

Technical Specifications

SINGLE LOUDSPEAKER PERFORMANCE		
Frequency Response (-3 dB) ⁽¹⁾	80 - 16,000 Hz	
Frequency Range (-10 dB) ⁽¹⁾	70 - 17,000 Hz	
Nominal Coverage Angle (H × V) (1 - 4 kHz)	130° × 125°	
Nominal Coverage (H × V) (1 - 10 kHz)	105° × 100°	
	AES transducer test ⁽⁵⁾	Bose extended-lifecycle test ⁽⁴⁾
Power Handling, (SPL, 1 W @ 1 m)	50 W	40 W
Power Handling, Peak	200 W	160 W
Sensitivity (SPL, 1 W @ 1 m) ⁽²⁾	89 dB	89 dB
Calculated Maximum SPL @ 1 m ⁽³⁾	106 dB	105 dB
Calculated Maximum SPL @ 1 m, Peak	112 dB	111 dB
Loudspeaker EQ	Not required, Bose EQ voicing and SmartBass available	
Recommended High-Pass Protection	70 Hz with minimum 24-dB/octave filter	
Transformer Taps	70V: 2.5, 5, 10, 20, 40 W, bypass	
	100V: 5, 10, 20, 40 W, bypass	
TRANSDUCERS		
Full-Range Driver	1 × 4.5-inch woofer (114 mm)	
Nominal Impedance	8 ohms (transformer bypass)	

FreeSpace FS4SE

surface-mount loudspeaker

PHYSICAL	
Enclosure Material	Engineered plastics, highly UV fade-resistant
Bracket Material	Powder-coated steel
Grille	Perforated steel, powder-coated finish, tamper-resistant design
Logo	Rotatable, removable
Color	Black: similar to Ral 9005, White: similar to Ral 9003
Environmental/Ingress Protection ⁽⁶⁾	Rated for direct-exposure outdoor installations (IP55 per EN60529; IP33C per EN54-24). Suitable for use outdoors in wet locations. Includes weather-resistant input cover. Optional accessory aluminum grille for harsh environments to prevent red corrosion is available.
Safety Agency	Certification: EN54-24:2008 for Voice Alarm Systems, UL 1480 UUMW, CAN/ULC-S541 UUMW7 for Speakers for Fire Alarm and Signaling Systems. Installation: NFPA 70, NFPA 72, CSA C22.1 Section 32 For EN54-24 specifications, Refer to FS4SE EN 54-24 Certified Ratings document on pro.bose.com
Operating Temperature Range	-25 °C to 70 °C (-13 °F to 158 °F)
Connectors	Euroblock 6-pin connector with loop-through, mounted on rear. Accepts 18 AWG (0.8 mm ²) to 14 AWG (2.5 mm ²) size wire.
Suspension/Mounting	External U-bracket with bracket screws
	7 preset mounting angles: 0°, +15°, +30°, or +45° for wall or ceiling placement
	Two (2) rear M8 screw inserts for use with optional Ceiling Mount Bracket S2, WBPWR-50 pan-and-tilt bracket (for outdoors), or RMUBRKT1 pan-and-tilt
	Safety cable can be used with either of two (2) rear M8 inserts when using included U-bracket, or with either of two (2) side M8 inserts, when using optional brackets
Dimensions (H x W x D)	254 x 171 x 174 mm (10.0 x 6.7 x 6.8 in)
Dimensions with Bracket (H x W x D)	273 x 171 x 196 mm (10.7 x 6.7 x 7.7 in)
Net Weight, Loudspeaker with Grille and Bracket (Single)	3.08 kg (6.80 lb)
Shipping Weight (Pair)	8.32 kg (18.35 lb)
Included Accessories	Each FS4SE includes one (1) Bose logo for vertical orientation, one (1) U-Bracket and one (1) weather-resistant input cover
Optional Accessories	Aluminum Grille kit (2-pack), WBPWR-50 pan-and-tilt bracket (for outdoors), RMUBRKT1 pan-and-tilt bracket (for indoors), Ceiling Mount Bracket S2, Ceramic Terminal and Thermal Fuse Kit (10-pack)
PRODUCT CODES	
841155-0310	FREESPACE FS4SE PAIR BLK
841155-0410	FREESPACE FS4SE PAIR WHT

Footnotes

- (1) Frequency response and range measured on-axis in half-space environment with recommended EQ
- (2) Sensitivity measured on-axis in half-space environment averaged 100 Hz - 10 kHz using recommended high-pass protection
- (3) Maximum SPL calculated from sensitivity and power handling specifications, exclusive of power compression
- (4) Bose extended-lifecycle test using pink noise filtered to meet IEC268-5, 6-dB crest factor, 500-hour duration
- (5) AES standard 2-hour duration with IEC system noise
- (6) Tested to IP55 per EN60529 when used in General Purpose Audio applications. Tested to IP33C per EN54-24 for fire and evacuation notification applications
- (7) Measured in whole-space environment

FreeSpace FS4SE

surface-mount loudspeaker

On-Axis Frequency Response

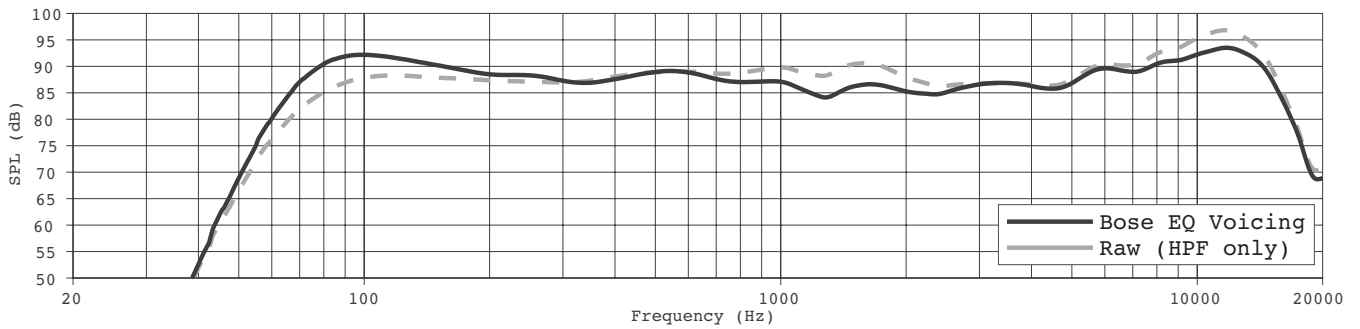

Impedance

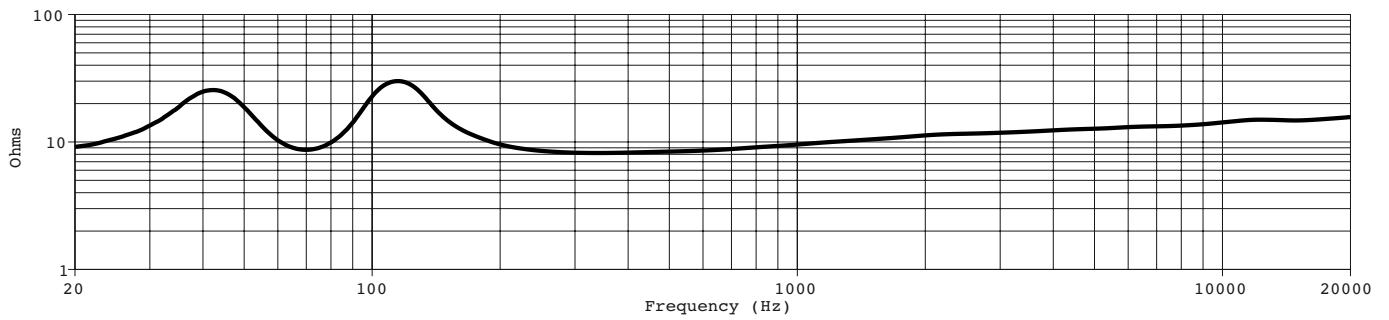

Beamwidth⁷

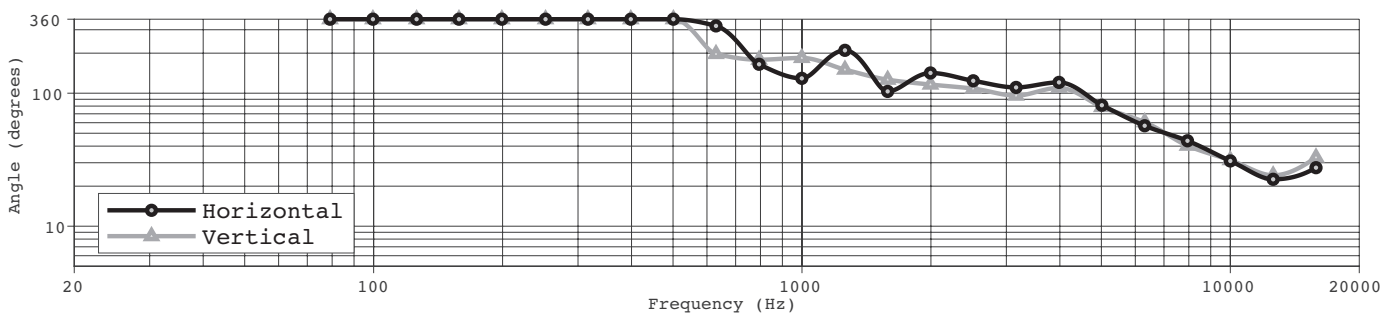

FreeSpace FS4SE

surface-mount loudspeaker

Dimensions

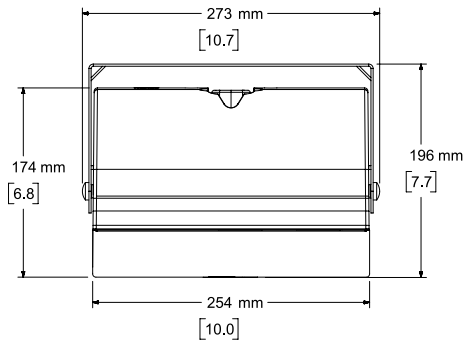

Top View

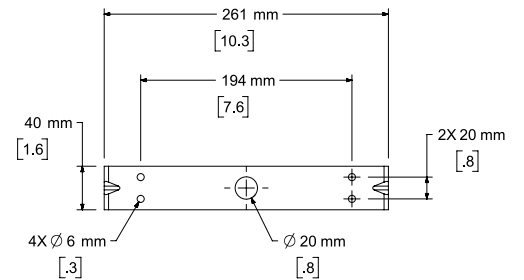
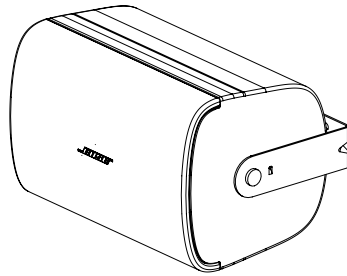

Rear View
BRACKET ONLY

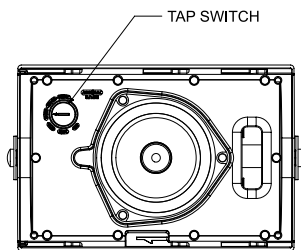

Front View
GRILLE REMOVED FOR CLARITY

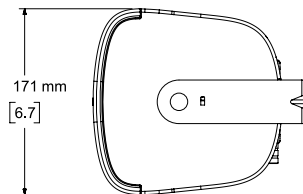

Right View
DIMENSIONS APPLY TO BOTH SIDES

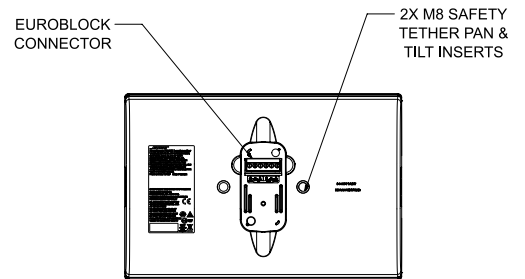

Rear View
BRACKET/CAP REMOVED FOR CLARITY

- NOTES:
1. DIMENSIONS ARE IN MILLIMETERS OVER INCHES
 2. WEIGHT APPROX 3.08kg [6.80lbs] (SPEAKER ONLY)
WEIGHT W/BRACKET APPROX 3.42kg [7.55lbs]

For additional specifications and application information, please visit PRO.BOSE.COM.
Specifications subject to change without notice. 07/2020